

Description:	Mohawk™	Model:	Various Motorcycles, Fork Diameter \leq 43mm
Part Number:	Chrome Mounts: N2833-001 Black Mounts: N2833-002	Installation Time:	30 min.

Thank you for purchasing a National Cycle product. Read these instructions carefully and thoroughly before beginning work. Dealers, if installing this windshield for a customer, please give them this manual. It contains information needed to properly maintain and use this product.



Attention:

Special notes and cautionary measures which can prevent damage to the accessory or vehicle.



Note:

Tips for facilitation of operation, control and adjustment, as well as maintenance work.

CLEANING AND MAINTENANCE To clean the screen, wash with a clean soft cloth, plenty of warm water and if necessary, a non-abrasive soap such as dishwashing liquid. Flannel or soft chamois make good cleaning cloths. **Paint, glue residue or grease removal:** Moisten cotton with naphtha or turpentine followed by a wash as above.

National Cycle **Shield Wash™** (N1401-01) makes a good daily cleaner and comes with a handy travel size bottle. Shield Wash is safe for all windshields and helmet visors.

Do not clean polycarbonate in hot sun or high temperatures. Do not clean the screen with glass cleaners. Do not allow brake fluid, alcohol, or strong solvents to contact the screen.

RAIN REPELLENT Do not use rain protective products made for glass. We recommend National Cycle's **RainZip®** (N1410-01) to help shed water in rainy weather.

! WARNING

Never ride your motorcycle with loose accessory mounting hardware. Check the hardware for tightness regularly.

Today's motorcycles are built with enough frame rigidity to withstand the moderate loads imposed on them by the foreseeable addition of an accessory(ies). If an accessory(ies) adversely affects your motorcycle's stability, immediately remove the accessory(ies). Do not ride a motorcycle that exhibits unsafe handling traits.

Have experienced service personnel correct any problem before riding with the accessory(ies) installed. For further questions concerning handling problems associated with an accessory(ies), contact your dealer, motorcycle manufacturer, or accessory manufacturer.

Sunlight reflected off the inside curvature of the windscreen can, at certain times of day, cause extreme heat buildup on the motorcycles instruments and possibly even melt them. Exercise care in parking to avoid this. Park your motorcycle facing the sun or place an opaque object over this area.



National Cycle 3-Year Limited Warranty

Register your windshield online at: www.nationalcycle.com/register.html

National Cycle hereby warrants to the original registered owner of a National Cycle polycarbonate windshield for a period of three years from the date of purchase against breakage. This limited warranty is expressly limited to the replacement of the polycarbonate windscreen. This limited warranty does not include scratches, coating failure, cosmetic wear and tear, replacement of hardware, or any consequential damages or expenses including labor cost of installation, removal and/or replacement, inconvenience, inbound freight expenses or damage to any other component of the motorcycle or any other accessories. Certain chemicals, generally known as acidic hydrocarbons, are known to cause polycarbonate damage and will not be covered under this limited warranty. Please refer to the cleaning instructions supplied with all National Cycle windshields.

Thank you for your purchase of a National Cycle Windshield. For further information please visit www.NationalCycle.com or call or write National Cycle, Inc.

PO Box 158 / Maywood, IL 60153 U.S.A. / 708-343-0400

Parts List For Kit-FC-001 included with N2833-001 and Kit-FC-003 included with N2833-002

Item	Part No.	Description	Qty.	Notes and Tools
1		Screen, Dark Tint Hardcoated Polycarbonate	1	Contained in N2831-001 and N2831-002
BAG#020, KIT-FC-001, CHROME				
2	37-371110-000	Outer Clamp, Chrome	2	Caliper to measure fork diameter (if unknown)
3	37-371120-000	Inner Clamp, Black	2	With Nut Welded to Bracket
BAG#1232, KIT-FC-003, BLACK				
2	37-371111-000	Outer Clamp, Black	2	Caliper to measure fork diameter (if unknown)
3	37-371120-000	Inner Clamp, Black	2	With Nut Welded to Bracket
BAG#020 and BAG#1232				
4	75-764010-000	.031" Rubber Spacer	2	Scissor or Cutting Blade
5	75-764012-000	.047" Rubber Spacer	2	"
6	75-764011-000	.062" Rubber Spacer	2	"
7	75-764014-000	.094" Rubber Spacer	2	"
8	75-764013-000	.125" Rubber Spacer	2	"
BAG#025, KIT-FA-001, CHROME				
9	37-371142-000	Bracket, Offset, Left, Chrome, Aluminum	1	
9a	37-371140-000	Bracket, Offset, Right, Chrome, Aluminum	1	
10	49-492550-000	Washer, Serrated, External	4	
11	51-515720-000	Screw, 8mm Allen	4	6mm Hex Wrench
BAG#1234, KIT-FC-003, BLACK				
9	37-371143-000	Bracket, Offset, Left, Black, Aluminum	1	
9a	37-371141-000	Bracket, Offset, Right, Black, Aluminum	1	
10	49-492550-000	Washer, Serrated, External	4	
11	51-515720-000	Screw, 8mm Allen	4	6mm Hex Wrench
BAG#1261, KIT-FC-001, CHROME and KIT-FC-003, BLACK				
12	37-371108-000	Slotted Bracket, Left, Black	1	
13	37-371109-000	Slotted Bracket, Right, Black	1	
14	49-495597-000	Collar, Stainless	4	
15	75-762012-000	Washer, Black	4	
16	51-518217-000	M6-1.0x 16 Stainless	4	4mm Hex Wrench
17	42-483005-000	Nut, Cap, Black	4	10mm Socket with Driver

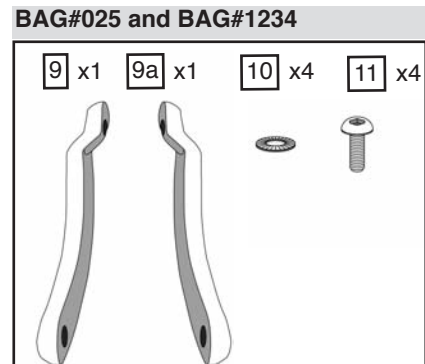
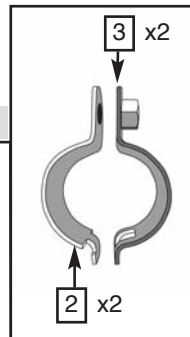
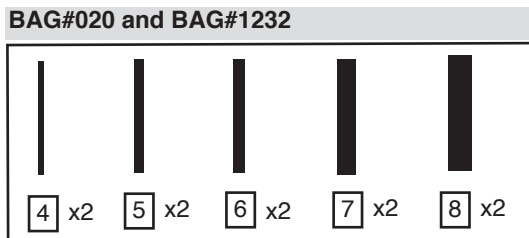
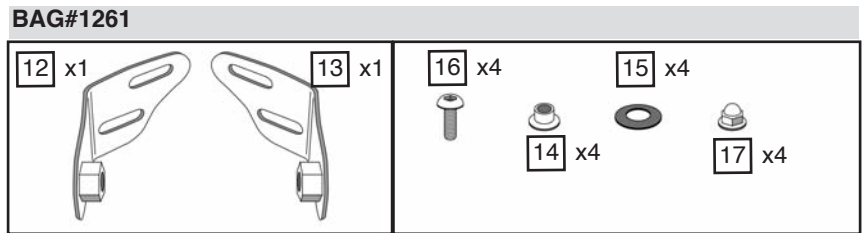
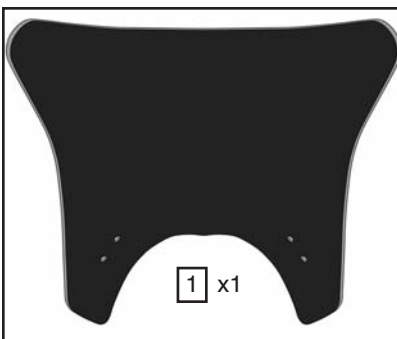

WINDSHIELD INSTALLATION

Preparing the Fork Clamps

1. Measure the motorcycle fork:

Diameter of Tube: _____

Width, Center to Center: _____

(Caliper or Soft Tape Measure) **Figure 1**

2. Refer to the Gasket Chart below and select the correct gaskets for your motorcycle fork diameter.

 One Gasket Strip is required for each fork.

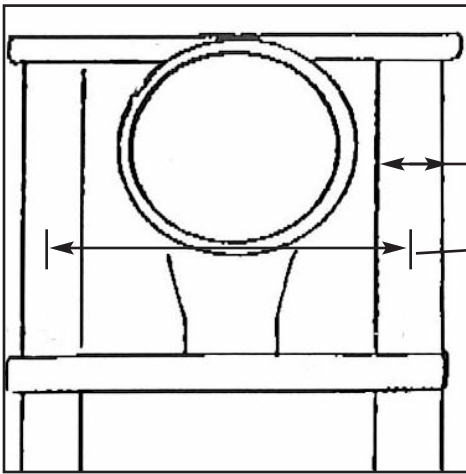

Figure 1

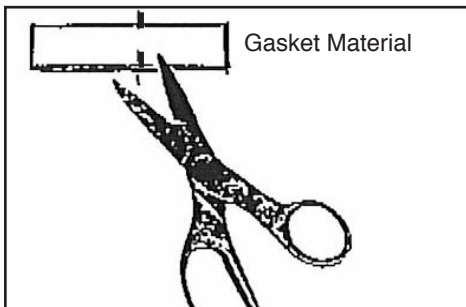

Figure 2

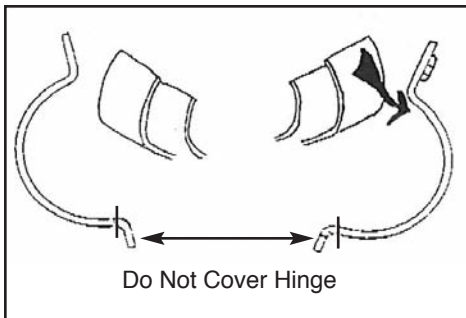

Figure 3

Gasket Chart

Fork Diameter	Qty.	Gasket Gauge Needed		
31mm	2	.094"	.062"	.125"
33mm	2	.047"	.062"	.125"
34.6mm	2	.031"	.047"	.125"
35mm	2	.047"	.062"	.094"
36mm	2	.047"	.125"	
37mm	2	.062"	.094"	
38mm	2	.047"	.094"	
39mm	2	.125"		
40mm	2	.094"		
41mm	2	.031"	.047"	
43mm	2	.047"		

3. Cut each Gasket into 2 pieces. You will need 1 piece for each **half** of the Clamp. **(Scissor) Figure 2**

4. Before removing paper backing from Gasket, fit Gasket to Clamp to verify correct length. Cut Gasket material to exact length of Clamp half. **(Scissor) Figure 2 and 3**

5. Remove paper backing and apply the required Gasket(s) to each Clamp half. **Do Not Apply Gasket Over Hinge. Figure 3**

Install Bracket Left (12) and Right (13) to Screen

6. Install 1, Washer (15) over each hole in the Screen. **Figure 4**

7. Select the Left Bracket (12) and install to the Left, Inside surface of the windscreen using 2, Collars (14), 2, Screws (16) and 2, Nuts (17) as shown in **(4mm Hex Wrench and 10mm Socket) Figure 4**.

8. Repeat on Right Side.

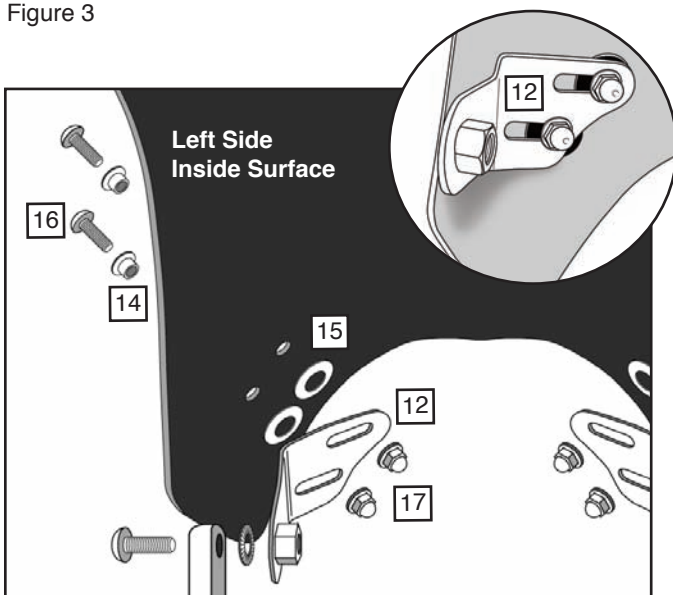

Figure 4

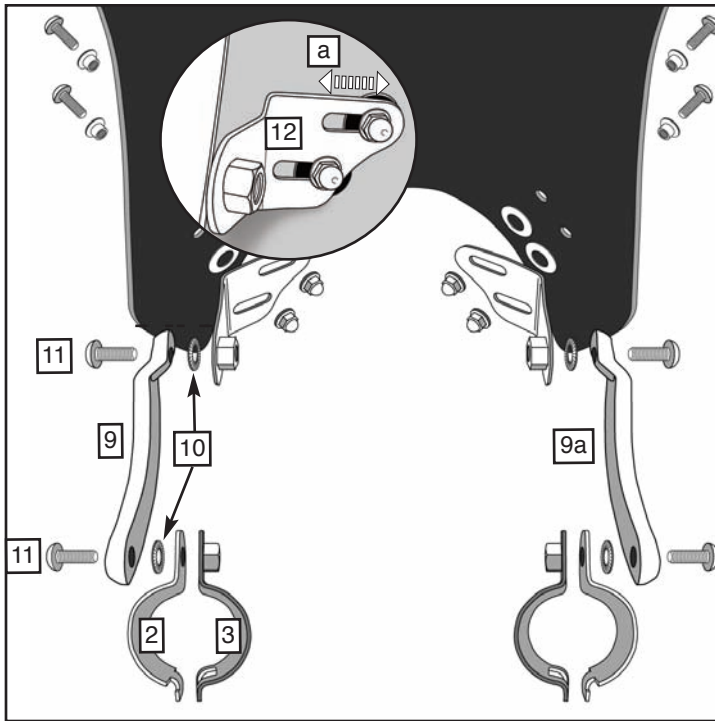

Figure 5

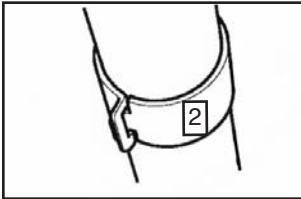

Figure 6

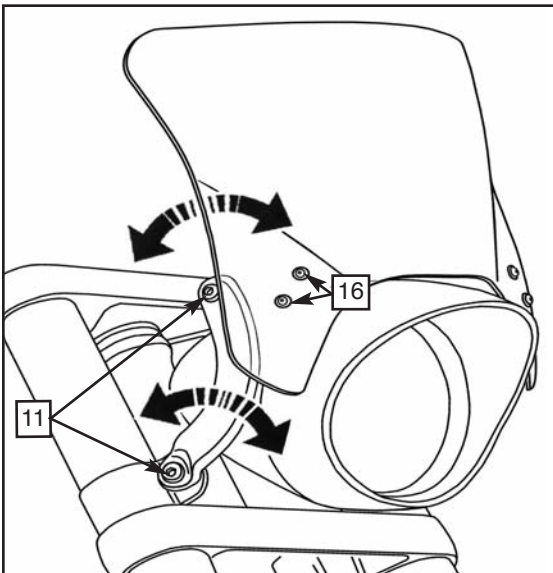



Figure 7

Assemble Offset Brackets to Windscreen

 Holding Windshield up to motorcycle will help determine position of Inside Bracket (12).

9. Use the fork width measurement to determine:
a. Adjustment of Inside Bracket (12)

10. Install the Left Offset Bracket (9) to the Inner Bracket (12) with 1, Serrated Washer (10) and Screw (11). **(6mm Hex Wrench) Figure 5**

11. Repeat on Right side using Right Offset Bracket (9a). **(6mm Hex Wrench) Figure 5**

Install Windshield to Fork with Fork Clamps

12. Hold Windshield up to the motorcycle to check adjustment and determine Fork Clamp position.

13. Hold Inner Clamp (3) to inside of fork tube, hook Outer Clamp (2) to the Inner Clamp. **Figure 5 and 6**

14. Secure Clamp Assemblies to the Offset Brackets (9 and 9a) with remaining M6 Screws (11) and Washers (10). **(6mm Hex Wrench) Figure 5.**

Final Adjustments and Tightening

15. Adjust the Windshield to the desired position and securely tighten the 4 Screws (11). **(6mm Hex Wrench) Figure 7**

16. Securely tighten the 4 Screws (16) and Nuts (17) in the Windshield Brackets **(4mm Hex Wrench and 10mm Socket) Figure 7**

Enjoy Your New Mohawk Windshield!